

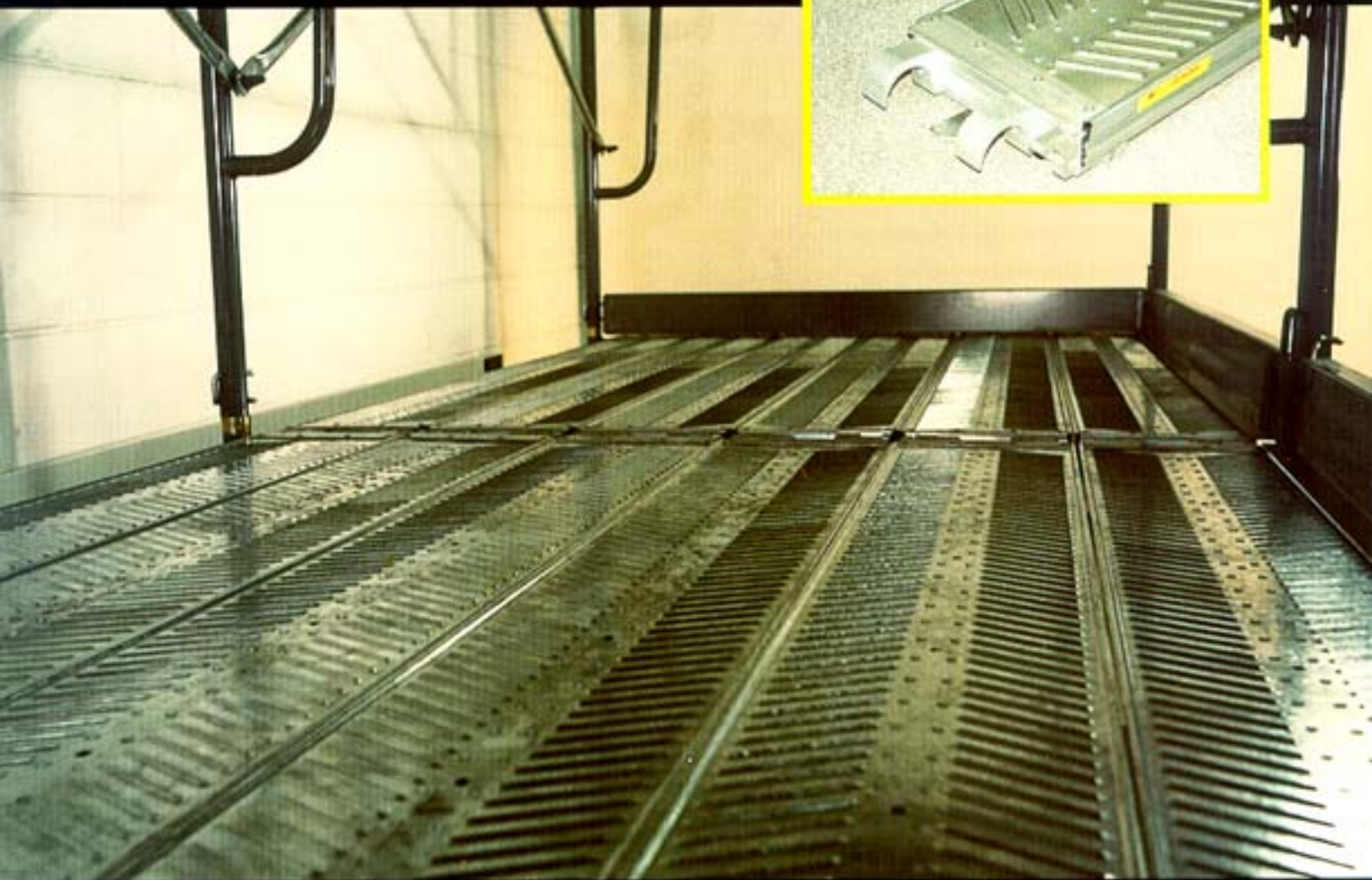

Introducing Duraplank™

Patent Pending



An Innovative Planking Solution

Duraplank™ Saves Labor Costs

Durable – Engineered product made of high-strength galvanized steel unlike some competitors' planks which are made with a less expensive, thinner gauge of rolled steel.

Visual Inspection – Easy to inspect. Unlike some wood plank, where damage can be internal, Duraplank can be thoroughly inspected with a simple visual inspection.

Flush Decking – Offsetting end hooks create flush decking which reduces tripping hazards caused by overlapping wood planks.

Fire Retardant – High-strength galvanized steel plank

creates fire-retardant decking for greater safety.

Better Traction – The unique raised herringbone surface provides better traction. Drainage holes on the surface eliminate standing water.

Strong – Duraplank is rated to support a 250 lb. center load on a 10' span.

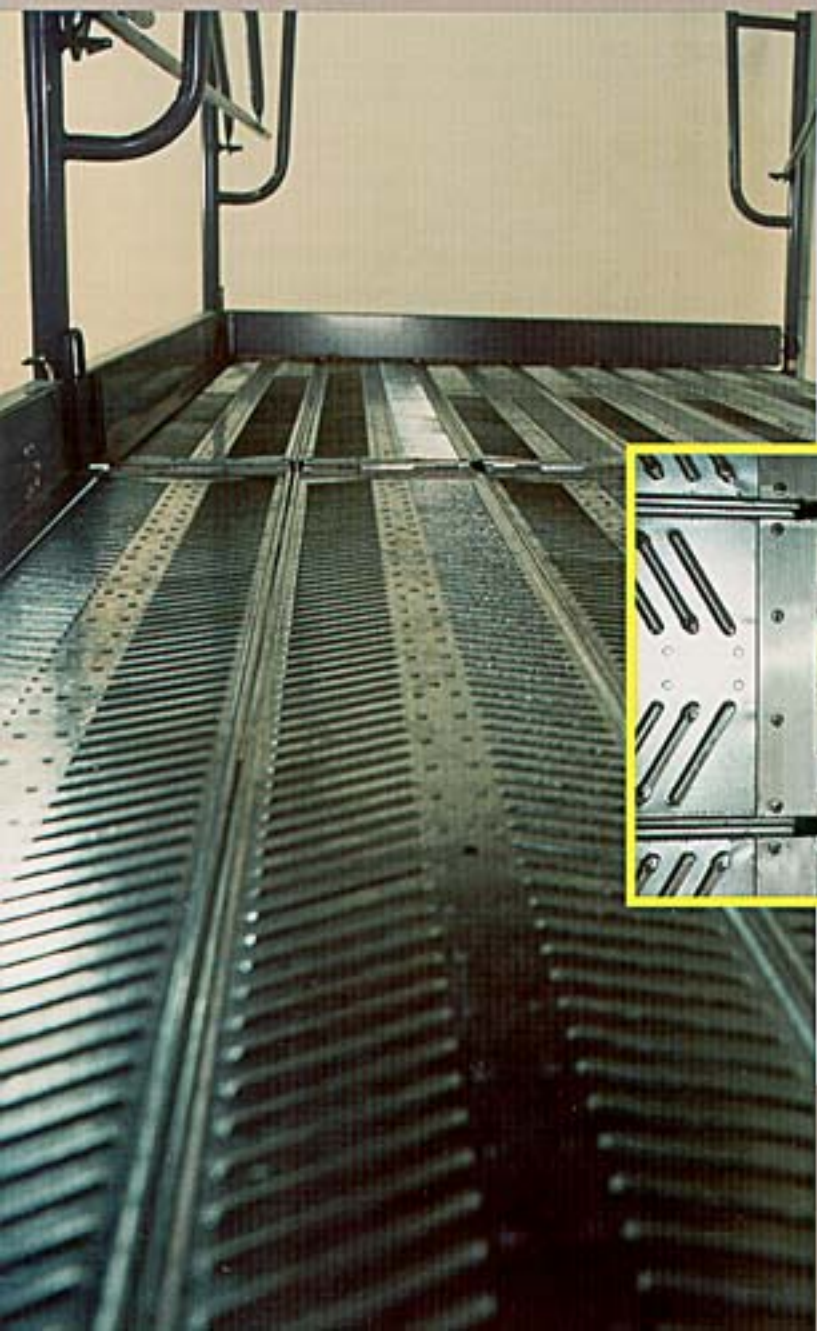

Offset hooks create flush decking, reducing tripping hazards.

High Hook raises the plank 1 3/4" above bearer for use with modular scaffolding area platforms.

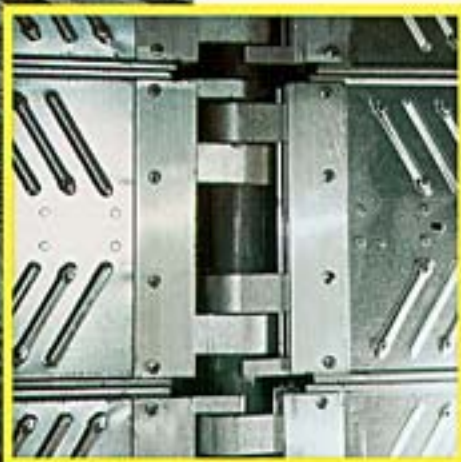

Interlocking planks create a continuous run of flush decking.

Raised herringbone surface with drainage holes creates better traction on the work surface, and eliminates standing water.



Duraplank™ Offers Multiple Planking Solutions

Long Life – Duraplank lasts much longer than wood plank, making it less expensive than wood over time.

Lighter – The unique hollow core design allows the new plank to weigh less than traditional wood decking. This creates efficiencies and enhances productivity when assembling scaffolding.

Hook Options – Both Low Hook and High Hook options are available. High Hook for use with modular scaffolding area platforms. Compatible with Safway Systems™ Plank. Low Hooks allow in-line installations for multiple bay scaffolds.

Replaceable “Low Hooks” – Replaceable “low” hooks make Duraplank repairable. If a hook becomes damaged or broken it can be replaced with a new one, allowing continued use of the plank.

“Low Hook” Wind Latch – Specially designed wind latch to prevent uplift during windy conditions.

Easy to Handle – A comfortable new grip-width provides easier handling and passing.

Multiple Lengths Available – Available in a full range of lengths from 2'-10'.

High Hook

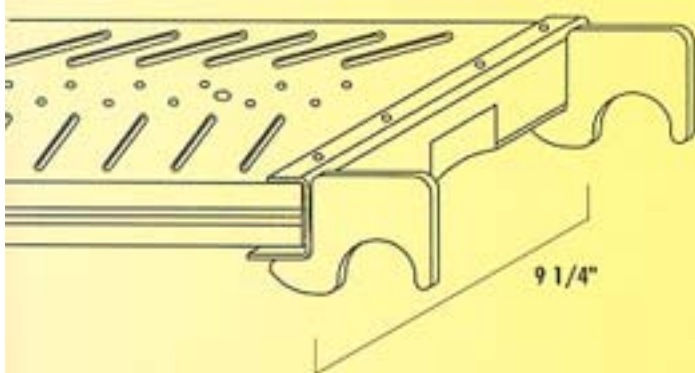

Low Hook

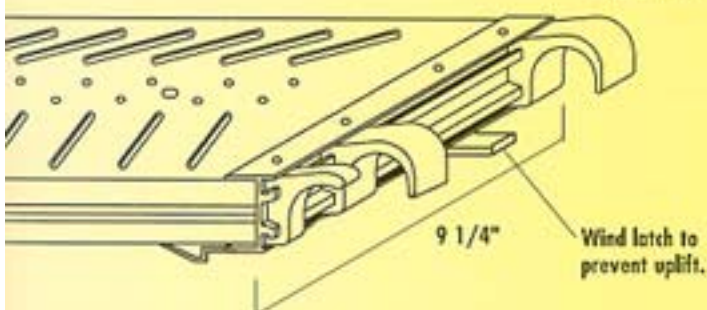

▲ *Offset hook options create flexibility allowing Duraplank to be used with both modular and sectional scaffolds.*



AVAILABLE LENGTHS

Part Number	Effective Length	Weight (lbs.)
SSPH2 . . .	2'-0" . . .	11.6
SSPH3 . . .	3'-0" . . .	14.7
SSPH42 . . .	3'-6" . . .	16.3
SSPH45 . . .	3'-9" . . .	17.1
SSPH4 . . .	4'-0" . . .	17.8
SSPH54 . . .	4'-6" . . .	19.4
SSPH5 . . .	5'-0" . . .	20.9
SSPH6 . . .	6'-0" . . .	24.1
SSPH7 . . .	7'-0" . . .	27.2
SSPH8 . . .	8'-0" . . .	30.3
SSPH9 . . .	9'-0" . . .	33.4
SSPH10 . . .	10'-0" . . .	36.5
FSPH2 . . .	2'-0" . . .	13.6
FSPH3 . . .	3'-0" . . .	16.1
FSPH42 . . .	3'-6" . . .	17.3
FSPH45 . . .	3'-9" . . .	17.9
FSPH4 . . .	4'-0" . . .	18.5
FSPH54 . . .	4'-6" . . .	19.7
FSPH5 . . .	5'-0" . . .	20.9
FSPH6 . . .	6'-0" . . .	23.4
FSPH7 . . .	7'-0" . . .	25.8
FSPH8 . . .	8'-0" . . .	28.3
FSPH9 . . .	9'-0" . . .	30.7
FSPH10 . . .	10'-0" . . .	33.2



Duraplank spans over post to provide continuous platform to the end of the side bracket.

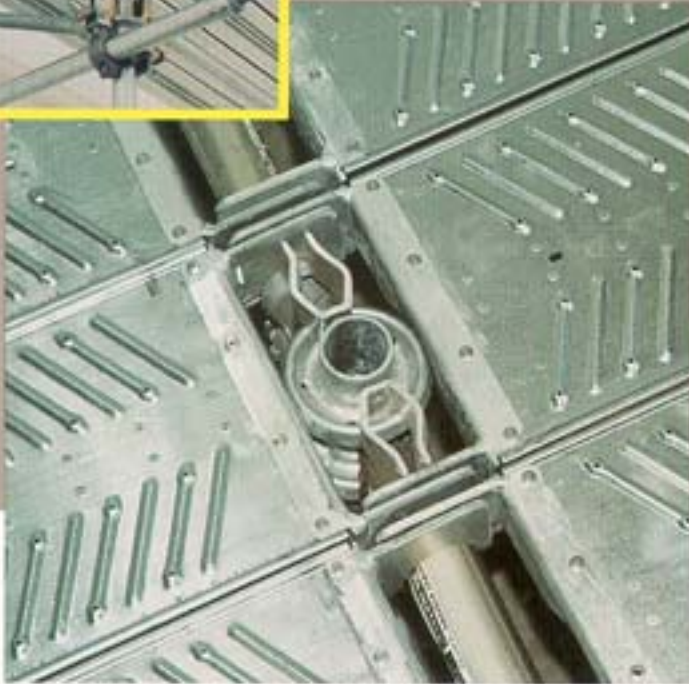

Outside Storage – Unlike wood, Duraplank won't warp, absorb water or gain weight when stored outdoors. All of which make it safer, lighter and easier to handle.

Corrosion Resistant – The galvanized steel creates a corrosion-resistant surface.

Reduced Theft and Damage – Galvanized steel Duraplank helps reduce theft often associated with aluminum planks.

Easy to Clean – Simple to hose off.

The High Hook allows Duraplank to span over the post, clearing end connectors, creating solid decking.



Duraplank can be used interchangeably with Safway Systems™ Planking.

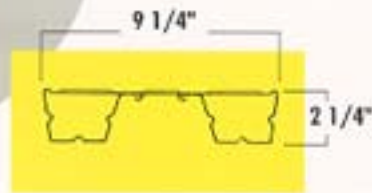

Duraplank's specially designed grip makes it easy to grab and pass.

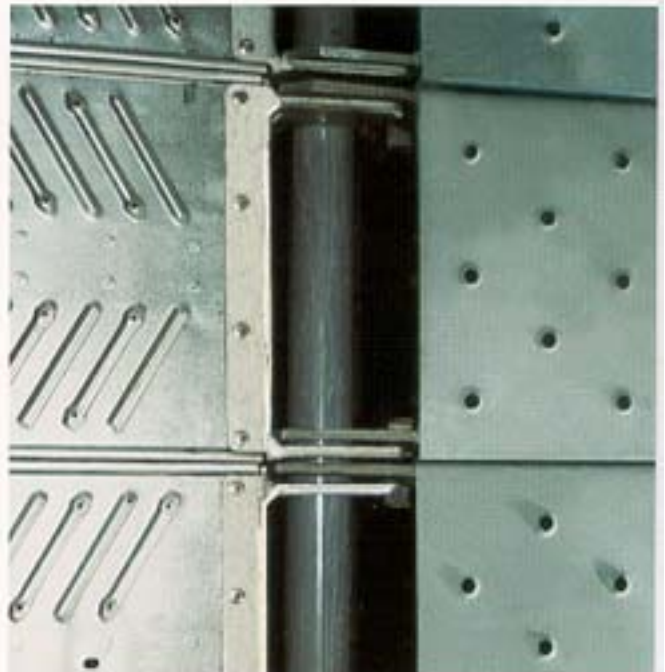

SAFWAY

Call your local Safway location (See back cover of this brochure) for current Duraplank pricing and availability.

Prefabricated Decking Options from SAFWAY

Safway continues to provide you with a complete line of decking options. Steel Planking for Systems™ Scaffolding, Aluminum and Plywood Planking, and all Aluminum Planking are also available from Safway.

SYSTEMS™ STEEL PLANKS (9" Wide)

Part Number	Effective Length	Weight (lbs.)
SSP-2	2'-0"	10.9
SSP-3	3'-0"	15.1
SSP-42	3'-6"	17.2
SSP-45	3'-9"	18.3
SSP-4	4'-0"	19.3
SSP-54	4'-6"	21.4
SSP-5	5'-0"	23.5
SSP-6	6'-0"	27.7
SSP-7	7'-0"	31.9
SSP-8	8'-0"	36.1
SSP-9	9'-0"	40.2
SSP-10	10'-0"	44.4

Heavy Duty – These heavy-duty steel planks are designed to work with Safway's Systems™ Scaffolding.

Corrosion Resistant – The galvanized steel creates a corrosion-resistant surface.

Fire Retardant – High-strength galvanized steel plank creates fire-retardant decking for increased safety in explosive environments.

Durability – These planks are made of high strength steel, making them less expensive than wood over their lifetime.

Multiple Lengths Available – Available in a full range of lengths from 2'-10'.



ALUMINUM AND PLYWOOD PLANKS (19 1/4" Wide)

Part Number	Effective Length	Weight (lbs.)
VAPA0507	5'-0"	22
VAPA0607	6'-0"	26
VAPA0707	7'-0"	30
VAPA0807	8'-0"	36
VAPA1007	10'-0"	47
VAPW5307-19	7'-0"	27
VAPW5310-19	10'-0"	47

Suitable for Many Uses – Construction and maintenance towers, as well as staging.

Low Maintenance Costs – Rugged aluminum frame resists damage.

Easily Replaceable – Plywood decks are easy to replace. Available lengths: 7', 8', and 10'.

End Hooks – Offsetting end hooks permit for continuous runs. Rigid planks hook onto the scaffold ledgers and help prevent scaffold from racking, eliminating the need for horizontal diagonal bracing at the planked level.

Overhang Eliminated – This provides easier access to rolling tower platforms and continuous flush decks.

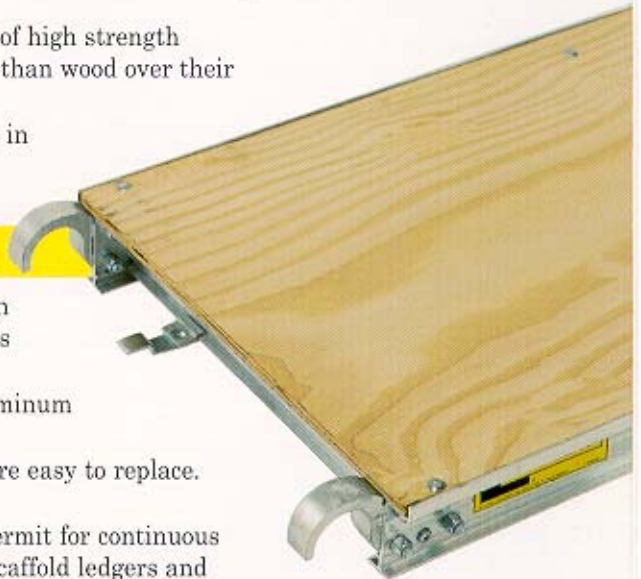

ALUMINUM PLANKS (19 1/4" Wide)

Part Number	Effective Length	Weight (lbs.)
VAPA0322	3'-0"	14.0
VAPA0422	4'-0"	18.0
VAPA0522	5'-0"	22.0
VAPA0622	6'-0"	26.0
VAPA0722	7'-0"	31.0
VAPA0822	8'-0"	33.0
VAPA0922	9'-0"	40.0
VAPA1022	10'-0"	41.0
VAPW5605-19	5'-0"	22.0
VAPW5607-19	7'-0"	30.0
VAPW5308-19	8'-0"	35.0

Lightweight – Half the weight of wood makes it easier to carry; faster to set up and take down.

Durable – Heavy-gauge, heat-treated aluminum extruded alloy that lasts.

Non-Combustible – All aluminum.

Ship-Ladder Surface – Safety tread surface for sure footing.

Flush Decking – No lap-end connectors, offset connector hooks for fast, fool-proof, "either-end" hookup.

Solid Bolt Construction – Throughout makes for fast, easy replacement of parts.

Low Maintenance – No lost time in lengthy maintenance.

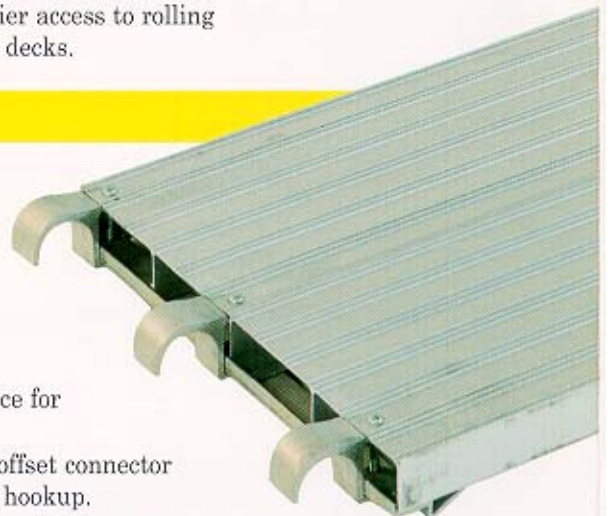

Branch Service Locations

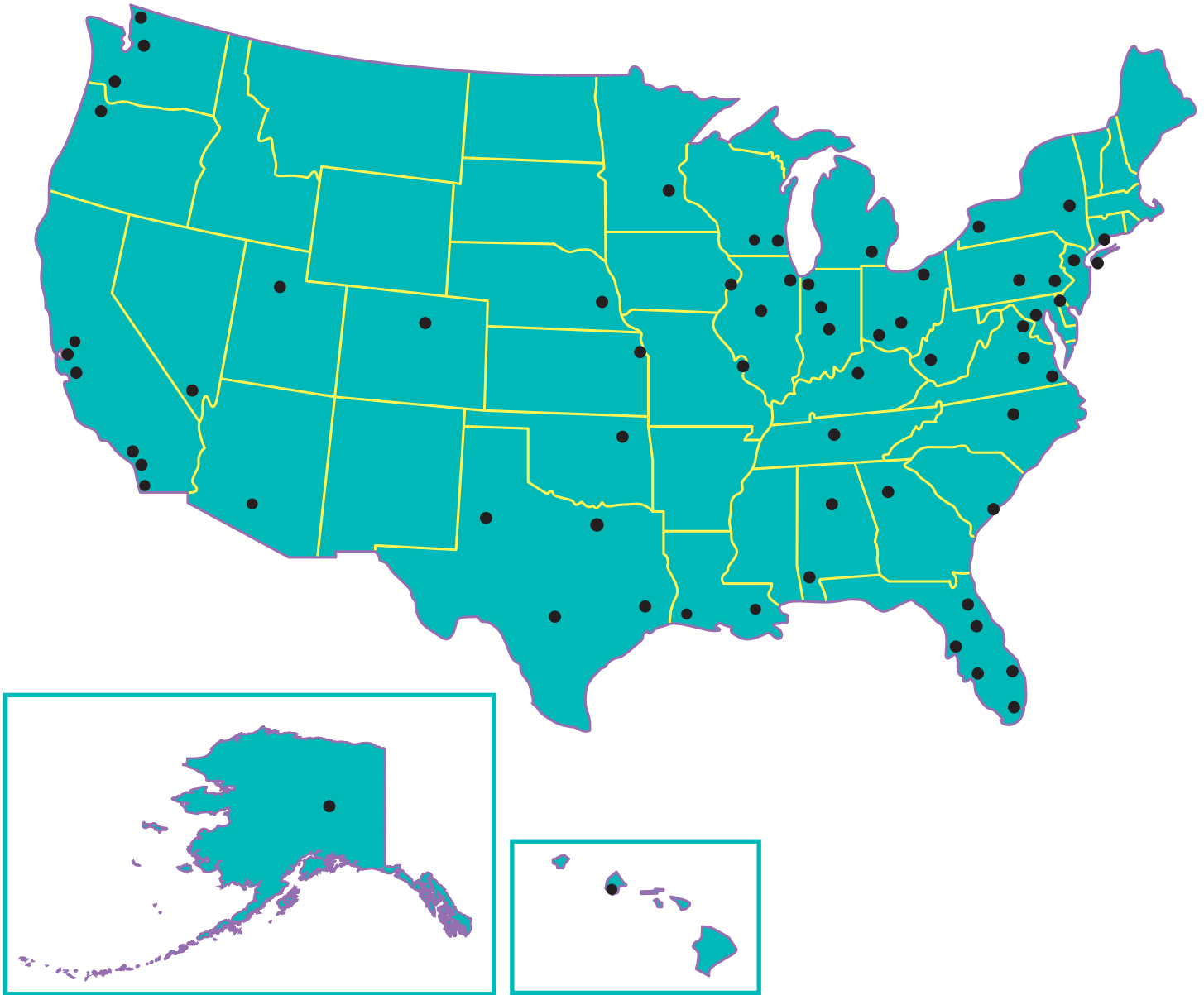

For a list of the nearest Safway Branch location (including Canada), visit:

www.safway.com



SAFWAY SERVICES, INC.

N19 W24200 Riverwood Drive
Waukesha, WI 53188
(800) 558-4772 ■ (262) 523-6500
Fax: (262) 523-9808

www.safway.com

The depictions in this brochure are for illustrative purposes only. This brochure is intended for general information only. Because of the many variables which affect the performance of Safway products, some of the information in this brochure may not apply. For specific applications, contact Safway.